

T035NSL940DAPW | RAY 75

Professional adjustable LED projector

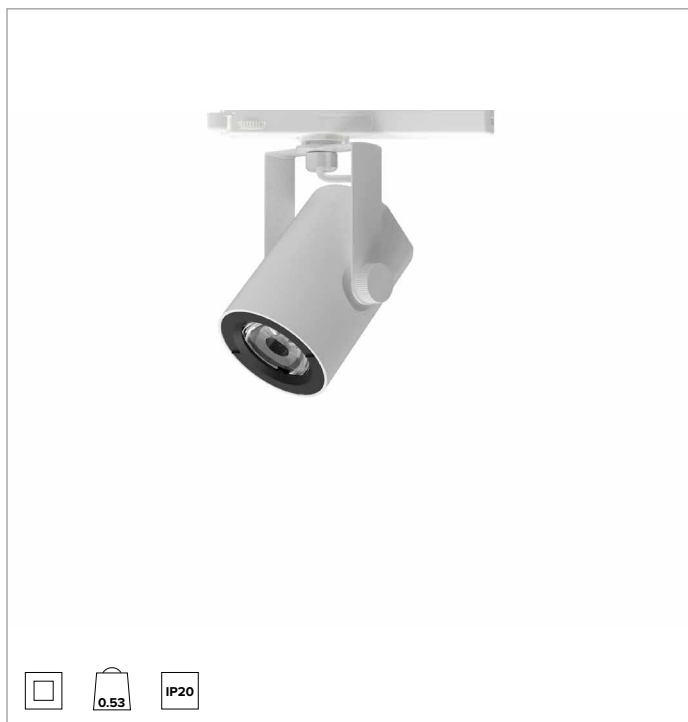

	4000K	H(m)	D(m)	Emax(lx)
	Ra90		10°	
Fixture Power	11W	1	0.17	23882
Source Flux	1024lm	2	0.34	5971
Fixture Flux	900lm	3	0.51	2654
Efficacy	84lm/W	4	0.68	1493
TS1920	Imax=23323cd/klm	Imax	23882cd	5
			0.85	955

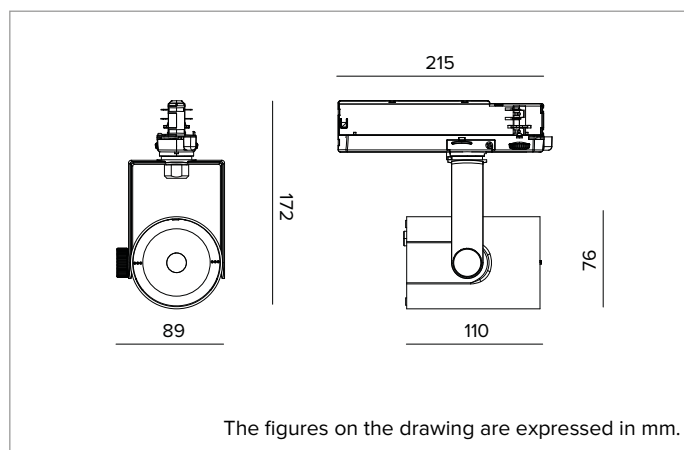

SOURCE

High efficiency Chip on Board LED Ra90. Ra97 on request.

Energy efficiency class: F
Nominal power: 9,3W
Nominal flux: 1024lm
Colour rendering index: 90
Rf: 90
Rg: 98
CCT nominal: 4000K
Lifetime (L80/B10): >50000h tq +25°C

ILLUMINOTECHNICAL CHARACTERISTICS

Optical grade PMMA TIR lens. Interchangeable lenses available as accessories (excluding the Narrow Spot optic).

Optic: LENS
Beam angles: NSP
Optical efficiency: 88%
Fixture flux: 900lm
Luminous efficacy: 84lm/W
Photobiological safety: Compliant with RG1 low risk group

MECHANICAL CHARACTERISTICS

Painted die-cast aluminium body. Black painted polycarbonate front ring. Adjustable from 0° to -90° on the vertical plane and 359° on the horizontal plane. Mechanical beam locking system on the vertical plane and friction beam locking system on the horizontal plane. The centre of gravity always remains in axis with the track regardless of the aiming.

Colour and finish: Plaster white
Dimensions: 75
Weight: 0.53Kg
Degree of protection: IP20

ELECTRICAL CHARACTERISTICS

DALI electronic driver integrated into the track adapter.

Fixture Power: 11W
Power supply: 220-240Vac 50/60Hz
Insulation Class: CLASS 2
Type of driver / Control: DALI - PUSH
Driver included: YES
Class F: YES
Ambient temperature: 0°C / +25°C

INSTALLATION

Electrified track mounting. Optical accessories that can be installed with a support ring are available.

NOTES

110-277Vac version available on request.

WARRANTY

5 years.

WARNING

Luminaire designed for disposal/recycling at end-of-life. Replaceable (LED only) light source by a professional. Replaceable control gear by a professional.

Due to the technological evolution of the electronic components, the data provided may be updated, and as such, confirmation must be requested during the order process.

Luminous flux and power supply have +/-10% tolerances with respect to the indicated value. tq +25°C (CIE 121).

We reserve the right to make technical changes.

Targetti Sankey S.r.l.
 Via Pratese, 164
 50145 Firenze - Italy
 Tel: +39 055 37911
 targetti.com
 targetti@targetti.com

CCIAA Firenze
 Share Capital:
 € 500.000,00
 VAT N. (IT):
 01537660480
 R.E.A: FI-275656

TARGETTI

T035NSL940DAPW | RAY 75
Professional adjustable LED projector

Accessories

Screen



Ø mm	Code
50	1T4325

Black painted anodized diffusive aluminium asymmetric screen.
Complete with blade light filter.
Ideal for a Wall Washer effect.
To be combined with spot and flood optics.
For RAY 75 versions with lens.

Grid



Ø mm	Code
50	1T4322

Anti-glare louver.
Black painted metal honeycomb structure.
Complete with holographic diffusion filter.
For RAY 75 versions with lens.

Filter



Ø mm	Code
50	1T4721

PMMA holographic filter with blade effect to ovalize the light beam; more evident when combined with spot and flood optics.
For RAY 75 versions with lens.

Bracket



Colour	Code
○	A058PW
●	A058DB

Rigid support bracket for projectors with Eurostandard Plus track attachment.
For compatibility and use please refer to the assembly instructions for the projectors.
For installation of Ray 75 projectors on wall vertical tracks.

Due to the technological evolution of the electronic components, the data provided may be updated, and as such, confirmation must be requested during the order process.
Luminous flux and power supply have +/-10% tolerances with respect to the indicated value. tq +25°C (CIE 121).

We reserve the right to make technical changes.

Targetti Sankey S.r.l.
Via Pratese, 164
50145 Firenze - Italy
Tel: +39 055 37911
targetti.com
targetti@targetti.com

CCIAA Firenze
Share Capital:
€ 500.000,00
VAT N. (IT):
01537660480
R.E.A: FI-275656

